

# R490 OBC MicroGC

## User manual



Dear user,

Thank you for choosing this SRA Instruments product.

This manual contains all the necessary information for the correct use of your instrument. Should you need further information or if you encounter any problems, please contact our After Sales Service:

Hotline: +33 (0)4 78 44 22 09  
E-mail : [service@sra-instruments.com](mailto:service@sra-instruments.com)

 <p><b>SRA</b> INSTRUMENTS ANALYTICAL SOLUTIONS</p>	<p>SRA Instruments 210 rue des Sources 69280 Marcy l'Etoile FRANCE</p>	<p>Tel : +33 (0)4 78 44 29 47 Fax : +33 (0)4 78 44 29 62 <a href="mailto:info@sra-instruments.com">info@sra-instruments.com</a> <a href="http://www.srainstruments.com">www.srainstruments.com</a></p>
--	--	--

## Table of contents

<b>1. INTRODUCTION</b>	<b>6</b>
<b>2. SAFETY INSTRUCTIONS</b>	<b>6</b>
2.1 For your protection	6
2.2 Safety and regulatory information	7
2.3 General safety precautions	8
2.4 To begin with	9
<b>3. TRANSPORT, CLEANING, AND DISPOSAL OF THE INSTRUMENT</b>	<b>9</b>
3.1 Shipping instructions	9
3.2 Cleaning	9
3.3 Instrument disposal	10
<b>4. INSTRUMENT OVERVIEW</b>	<b>10</b>
4.1 Presentation	10
4.2 Operating principle	10
4.3 Front view	11
4.4 Back view	11
4.4.1 Gas inlets and vents	11
4.4.2 Communication	12
4.5 Inside view	13
4.6 MicroGC cycle with constant pressure	13
<b>5. INSTALLATION AND USE</b>	<b>14</b>
5.1 Pre-installation requirements	14
5.2 Inspect the shipping packages	14
5.3 Unpack the MicroGC	14
5.4 Provide the necessary tools and accessories for installation	14
5.4.1 Tools	14
5.4.2 Accessories	15
5.5 Recommendations before installation	15
5.6 R490 OBC MicroGC installation : the 4 golden rules	15
5.6.1 Step 1 : Connect the carrier gas(es)	16
5.6.2 Swagelok fittings	16
5.7 Sample lines	18
5.7.1 Introduction	18
5.7.2 Sampling modes	18
5.8 Sample release outlet	18

<b>6. START-UP PROCEDURE</b>	<b>19</b>
6.1 Start-up the chromatograph	19
6.2 Launch the software	19
6.3 Load the PURGE method	19
6.4 Load the test method	20
6.5 Perform a series of runs	20
<b>7. STOP PROCEDURE</b>	<b>20</b>
7.1 Short time stops (less than 2 weeks)	20
7.2 Long stops of R490 OBC	21
7.3 Moving the analyzer	21
<b>8. THE MICROGC ANALYTICAL MODULE</b>	<b>21</b>
8.1 Micro Electronic Gas Control (EGC)	22
8.2 Inert Sample Path	22
8.3 Injector	22
8.4 Column	22
8.4.1 Molsieve 5Å columns	23
8.4.2 CP-Sil 5 CB columns	24
8.4.3 CP-Sil CB columns	25
8.4.4 PoraPlot 10m column	26
8.4.5 Hayesep A 40 cm heated column	27
8.4.6 COX and Al <sub>2</sub> O <sub>3</sub> /KCl columns	28
8.4.7 MES (NGA) and CP-WAX 52 CB columns	29
8.4.8 Column conditioning	30
8.5 Backflush option	30
8.5.1 Tuning the backflush time (except on a HayeSep A channel)	32
8.5.2 To disable backflush	32
8.6 μ-catharometer	32
<b>9. COMMUNICATIONS</b>	<b>33</b>
9.1 External digital I/O	33
9.2 RS-232	33
<b>10. ERRORS</b>	<b>34</b>
10.1 Error handling	34
10.2 Error list	34
<b>11. TECHNICAL DATA</b>	<b>39</b>
11.1 Power supply	39
11.2 Dimensions and weight	39
11.3 Working conditions	39

<b>11.4 Chromatographic modules</b>	<b>39</b>
11.4.1 Carrier gases	39
11.4.2 Sample and injection	39
11.4.3 Injector	39
11.4.4 Column	39
11.4.5 Detector	40
11.4.6 TCD operating range	40
11.4.7 TCD detection limits	40
11.4.8 Repeatability	40
<b>11.5 Embedded computer (OBC)</b>	<b>40</b>
<b>11.6 Modbus (optional)</b>	<b>40</b>
<b>11.7 Inputs / Outputs</b>	<b>41</b>
<b>11.8 Driving software</b>	<b>41</b>
<b>12. EU DECLARATION OF CONFORMITY</b>	<b>42</b>
<b>13. FREQUENTLY ASKED QUESTIONS</b>	<b>43</b>
13.1 My detector is in default status, what should I do?	43
13.2 My pressure sensor is in default status, what should I do?	43
13.3 I change the carrier gas, what should I do?	43

# 1. Introduction

For reasons of clarity, this manual does not contain all detailed information on all types of coupling. In addition, it cannot describe every possible case concerning installation, use and maintenance.

If you require additional information about this device or if you encounter problems that are not addressed in this manual, you can contact SRA Instruments for assistance.

The content of this manual is not part of any previous or existing agreement, commitment or legal status and does not change these. All the commitments of SRA Instruments are contained in the respective sales contracts, which also contain the only and entire applicable warranty terms. These warranty conditions in the contract are neither extended nor limited by the content of this manual.

## 2. Safety instructions

### Important information

This instrument is designed for chromatographic analysis of appropriately prepared samples. It must be operated using appropriate gases or solvents and within specified maximum ranges for pressure, flows, and temperatures as described in this manual. If the equipment is used in a manner not specified by SRA Instruments, the protection provided by the equipment may be impaired.

It is the responsibility of the customer to inform SRA Instruments after-sales service if the instrument has been used for the analysis of hazardous samples, prior to any instrument service being performed or when an instrument is being returned for repair.

### 2.1 For your protection

#### Warnings:

##### Warning: Shock hazard



Do not replace components while the power cable is plugged in. To avoid injuries, always turn off power before touching them. Install the R490 OBC MicroGC so that access to the power cable is easy. Make sure that you connect the cable to an earth socket, otherwise there is a lethal hazard.

##### Warning: Hot surfaces



Several parts of the R490 OBC MicroGC work at temperatures high enough to cause severe burns. These parts include, among others:

- the oven
- the columns

You must be extremely careful to avoid touching these heated surfaces. Do not use the instrument if the R490 OBC MicroGC is disassembled.

##### Warning: Electrostatic discharge is a threat to electronics



Electrostatic discharge (ESD) can damage the printed circuit boards of the R490 OBC MicroGC. If you must hold an electronic card wear a grounded wrist strap and hold it only by its edges.

### Warning: Use of gases



Do not use gases that can form an explosive mixture. Avoid using hydrogen as the carrier gas or purge gas for your analyses.

### Warning concerning the use of hydrogen

When using hydrogen (H<sub>2</sub>) as the carrier gas, be aware that hydrogen gas can create a fire or explosion hazard. Be sure that the supply is turned off until all connections are made.

Hydrogen is highly flammable. Leaks, when confined in an enclosed space, may create a fire or explosion hazard.

In any application using hydrogen, leak test all connections, lines, and valves before operating the instrument. Always turn off the hydrogen supply at its source before working on the instrument.

- Hydrogen is combustible over a wide range of concentrations.  
At atmospheric pressure, hydrogen is combustible at concentrations from 4 % to 74.2 % by volume.
- Hydrogen has the highest burning velocity of any gas.
- Hydrogen has a very low ignition energy.
- Hydrogen that is allowed to expand rapidly from high pressure into the atmosphere can self-ignite.
- Hydrogen burns with a nonluminous flame which can be invisible under bright light.

### Warnings related to chemical products

When handling or using chemicals for preparation or use within the MicroGC, all applicable local and national laboratory safety practices must be followed. This includes, but is not limited to, correct use of Personal Protective Equipment, correct use of storage vials, and correct handling of chemicals, as defined in the laboratory's internal safety analysis and standard operating procedures. Failure to adhere to laboratory safety practices could lead to injury or death.

## 2.2 Safety and regulatory information

This instrument and its accompanying documentation comply with the CE specifications and the safety requirements for electrical equipment for measurement, control, and laboratory use.

This device has been tested and found to comply with the limits required by regulations. These limits are designed to provide reasonable protection against harmful interference when the equipment is operated in a commercial environment. This equipment generates, uses, and can radiate radio frequency energy. If it is not installed and used in accordance with the user manual, it may cause harmful interference to radio communications.

NOTICE: This instrument has been tested per applicable requirements of EMC Directive as required to carry the European Union CE Mark. As such, this equipment may be susceptible to radiation/interference levels or frequencies, which are not within the tested limits.



This symbol confirms that the R490 OBC complies with all electrical safety regulations.

## 2.3 General safety precautions

Follow the following safety practices to ensure safe equipment operation:

- Perform periodic leak checks on all supply lines and pneumatic plumbing.
- Do not allow gas lines to become kinked or punctured.  
Place lines away from foot traffic and extreme heat or cold.
- Avoid exposure to potentially dangerous voltages. Disconnect the instrument from all power sources before removing protective panels.
- When it is necessary to use a non-original power cord and plug, make sure the replacement cord adheres to the colour coding and polarity described in the manual and all local building safety codes.
- Replace faulty or frayed power cords immediately with the same type and rating.
- Place this instrument in a location with enough ventilation to remove gases and vapours. Make sure there is enough space around the instrument so that it can cool sufficiently.
- Before plugging the instrument in or turning the power on, always make sure that the voltage and fuses are set appropriately for your local power source.
- Do not turn on the instrument if there is a possibility of any kind of electrical damage. Instead, disconnect the power cord and contact SRA Instruments.
- The supplied power cord must be inserted into a power outlet with a protective ground connection. When using an extension cord, make sure that the cord is also properly grounded.
- Do not change any external or internal grounding connections, as this could endanger you or damage the instrument.
- The instrument is properly grounded when shipped. You do not need to make any changes to the electrical connections or to the instrument chassis to ensure safe operation.
- When working with this instrument, follow the regulations for Good Laboratory Practices (GLP). Take care to wear safety glasses and appropriate clothing.
- Do not place containers with flammable liquids on this instrument. Spilling liquid over hot parts may cause fire.
- This instrument may use flammable or explosive gases, such as hydrogen gas under pressure. Before operating the instrument be sure to be familiar with and to follow accurately the operation procedures prescribed for those gases.
- Never try to repair or replace any component that is not described in this manual without the assistance of SRA Instruments. Unauthorized repairs or modifications will result in rejection of warranty claims.
- Always disconnect the AC power cord before attempting any type of maintenance.
- Use the proper tools when working on the instrument to avoid endangering yourself or damaging the instrument.
- Do not attempt to replace the battery or a fuse in this instrument with parts not specified in the manual.
- Damage can result if the instrument is stored under unfavourable conditions for prolonged periods. (For example, damage will occur if stored while subject to heat, water, or other conditions exceeding the allowable operating conditions).
- Do not shut off column flow when the oven temperature is high, since this may damage the column.
- This instrument has been designed and tested in accordance with recognized safety standards and designed for use indoors.



- If the instrument is used in a manner not specified by the manufacturer, the protection provided by the instrument may be impaired.
- Substituting parts or performing any unauthorized modification to the instrument may result in a safety hazard.
- Changes or modifications not expressly approved by the responsible party for compliance could void the user's authority to operate the equipment.

## 2.4 To begin with

- Check that the operating voltage of the instrument is compatible with the one of your electrical network before switching it on. Otherwise the device may be damaged.
- Use only gases and solvents specified in the operating procedures.
- Do not open the instrument without the permission of SRA Instruments.
- Eliminate from the environment of the instrument: vibrations, magnetic effects and explosive gases.
- The R490 OBC MicroGC must only be used indoors; it is designed for use at room temperature and under conditions where no condensation can occur. Install the R490 OBC MicroGC on a rigid and stable surface.
- Have your instrument serviced by SRA Instruments.

## 3. Transport, cleaning, and disposal of the instrument

### 3.1 Shipping instructions

If your MicroGC must be shipped for any reason, it is very important to follow these additional shipping preparation instructions:

- Place all the vent caps on the back of the MicroGC.
- Always include the power supply.
- Include, if used, the inlet filter(s).

### 3.2 Cleaning

To clean the surface of the MicroGC:

1. Switch the MicroGC off.
2. Remove the power cable.
3. Put protection plugs on the sample and carrier gas inlets.
4. Put protection plugs on the column vents.
5. Use a soft brush (not hard or abrasive) to carefully brush away all dust and dirt.
6. Use a soft, clean cloth dampened with mild detergent to clean the outside of the instrument.
  - Never clean the inside of the instrument.
  - Never use alcohol or thinners to clean the instrument; these chemicals can damage the case.
  - Be careful not to get water on the electronic components.
  - Do not use compressed air to clean the instrument.

### 3.3 Instrument disposal

When the MicroGC or its parts have reached the end of their useful life, dispose of them in accordance with the environmental regulations that are applicable in your country.

## 4. Instrument overview

### 4.1 Presentation

The R490 OBC MicroGC is a rack in which a maximum of 3 analytical channels of 490 MicroGC, and an on-board computer (OBC), are associated.



Rack 5U

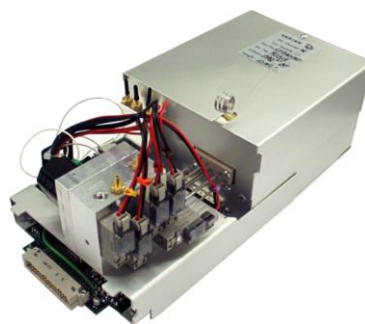

Analytical channel

### 4.2 Operating principle

The R490 OBC MicroGC can be equipped with 1 to 3 independent analytical channels. Each channel is a miniaturized and complete GC, including:

- A micro-machined injector
  - An analytical column of small diameter
  - A micro catharometer ( $\mu$  TCD)
  - An electronic gas control
- } Module

Chapter 8 provides a detailed overview of how a MicroGC analytical module works.

### 4.3 Front view



4 LEDs on the front panel indicate the status of the analyzer:

- READY: Lighted when the analyzer is ready for operation
- RUN: Lighted when an analysis is in progress
- ERROR: Lighted when there is an error
- POWER: Lighted as soon as the analyzer is switched on

### 4.4 Back view

#### 4.4.1 Gas inlets and vents



#	Designation	Connector type	Recommendations
1	Carrier gas inlet	Swagelok 1/8" male + fritted	Pressure 5.5 bar ; Purity 99.9996 %
2	Analysis TCD vent	Swagelok 1/8" male	Atmospheric pressure
3	Backflush vent	Swagelok 1/8" male	Atmospheric pressure
4	Reference TCD vent	Swagelok 1/8" male	Atmospheric pressure
5	Sample outlet	Swagelok 1/8" male	Atmospheric pressure
6	Sample inlets 1 & 2	Swagelok 1/16" inert male + fritted	Pressure 1 bar max ; gas

Note: For trace analysis, the recommended gas purity is 99.9999%.

### 4.4.2 Communication

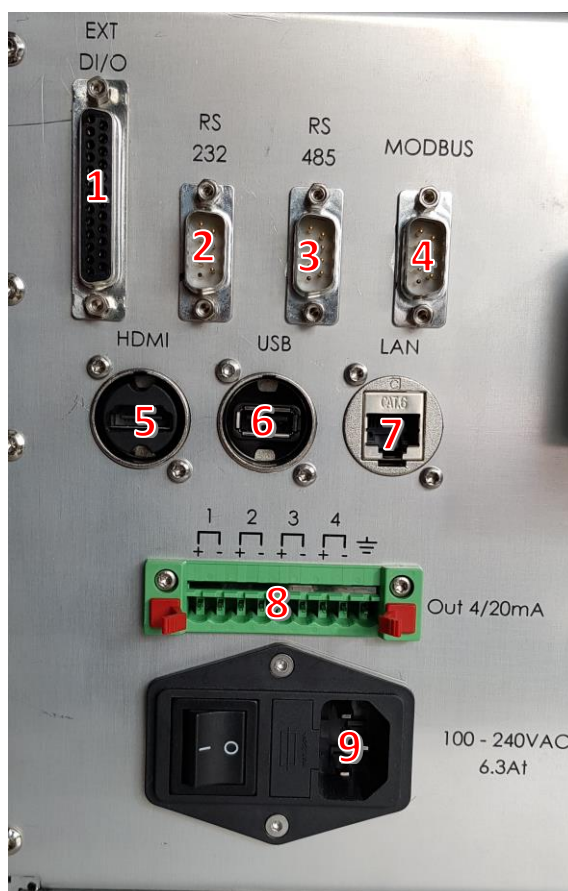

#	Connector type	Source	Designation	Use
1	Digital I/O	MicroGC	Digital inputs/outputs	External commands
2	RS232	MicroGC COM2	RS232 serial port	Stream selector
3	RS485	OBC COM1	RS485 serial port	Optional commands
4	Modbus RS485	OBC COM2	Modbus serial port	Modbus
5	HDMI + cover	OBC	Screen plug	Maintenance operations
6	USB + cover	OBC	Keyboard plug	Maintenance operations
7	Ethernet	OBC	Ethernet plug	Remote control and display
8	4-20mA	OBC	Analog inputs/outputs	Analog data transmission (option)
9	Power In + switch + fuse 6.3At	-	Power supply	-

See Chapter 9 of this manual as well as your instrument's specific manual for more details on Inputs/Outputs.

## 4.5 Inside view

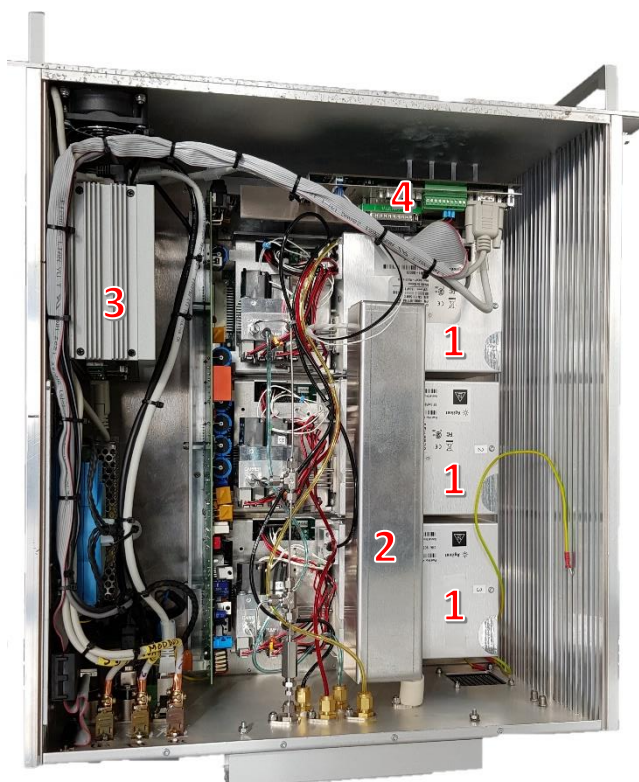

- 1: Analytical module
- 2: Heated sample distribution manifold
- 3: Computer
- 4: MicroGC main board

## 4.6 MicroGC cycle with constant pressure

The timing diagram below provides an overview of the cycle of the MicroGC at constant pressure.

This description is only for one channel. In most cases, when a two- or three-channel system is used, the sequence is the same but the timing settings can differ. If the sample time on channel A and channel B or C are different, the longest time will be used. Also, the run time can be specified per channel; the data acquisition stops per channel as soon as the run time has elapsed. The total analysis time depends on the longest run time.

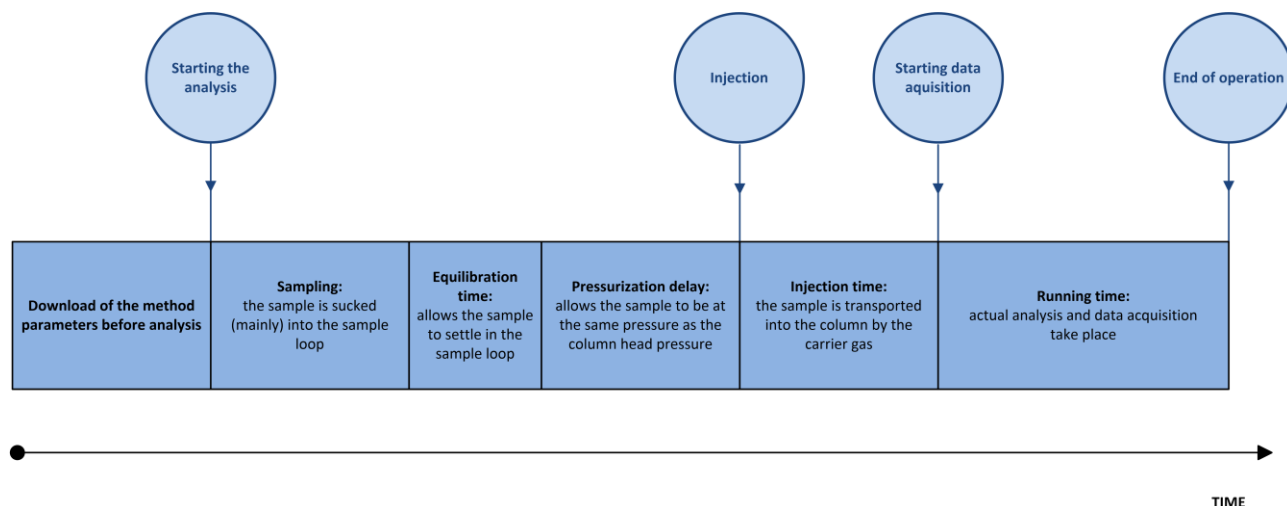

## 5. Installation and use

This chapter describes how to install and use the instrument.

### 5.1 Pre-installation requirements

Prepare the installation site as described in the “R490 MicroGC Installation prerequisites” manual.

### 5.2 Inspect the shipping packages

The MicroGC will arrive in one large box and one or more smaller cartons. Inspect the cartons carefully for damage or signs of rough handling. Report damage to the carrier and to SRA Instruments.

### 5.3 Unpack the MicroGC

Unpack the MicroGC and accessories carefully and transfer them to the work area using proper handling techniques. Inspect the instrument and accessories carefully for damage or signs of rough handling. Report damage to the carrier and to SRA Instruments.

**Warning:** Avoid back strain or injury by following all safety precautions when lifting heavy objects.

**!** The instrument has been protected during shipment by protective caps (see picture below). Before use, remove these caps, including those on the back panel.

Protective shipping caps

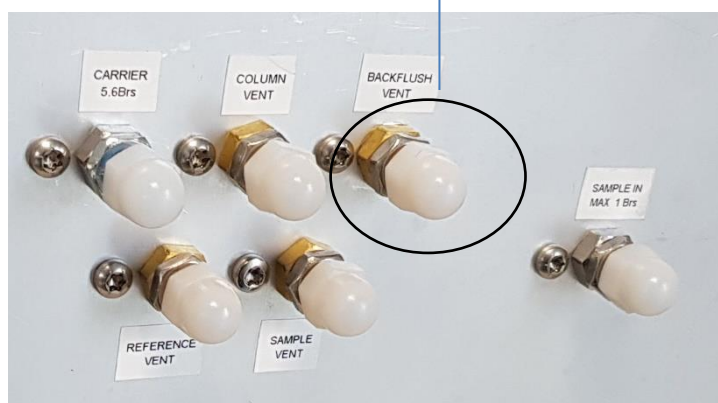

### 5.4 Provide the necessary tools and accessories for installation

#### 5.4.1 Tools

- 1/8" copper or stainless-steel tubing for carrier gas connection
- 1/8" Swagelok nuts, and ferrules
- 1/16" stainless-steel tubing for sample connection
- 1/16" Swagelok nuts, and front and back ferrules
- Two 7/16" wrenches
- 5/16" wrench
- 9/16" wrench
- 1/4" wrench
- Torx T-20 screwdriver



### 5.4.2 Accessories

Electronic leak detector (optional).

Note: Do not use a liquid leak detector: liquid can contaminate the analyzer.

## 5.5 Recommendations before installation

### Venting

Avoid discharging gaseous effluents into an area that may experience pressure fluctuations (wind or releases with variable temperature). Changes in pressure can affect the stability of the baseline and the sensitivity of the analyzer. For releases outside atmospheric pressure (e. g. glove boxes) please contact SRA Instruments to find a suitable solution.

### Tubes

- The diameter of the tubes depends on the distance between the gas cylinder and the analyzer and the total flow rate required. The use of 1/8" tube is correct for a line length of less than 5 m. Beyond that, or when several analyzers are connected to the same gas inlet, the use of 1/4" tube is preferable.
- Do not use sealings: they may contain volatile materials that may contaminate the distribution system.

### Optimization of gas purity

To get the best carrier gas quality on your analyzer:

- Use a pressure reducer adapted to your needs.
- Use suitable tubes and ferrules.
- Purge correctly dead volumes before connecting the tube to your analyzer.
- Confirm the absence of leaks with an electronic detector.
- Always send to MicroGC a purge method (with TCD OFF) to purge the dead volumes of the analyzer and column before setting the detector ON.

## 5.6 R490 OBC MicroGC installation : the 4 golden rules

MicroGC technology is easy to use. No chemical or analytical knowledge is required for basic use and setup. However, as with any analysis instrument, there are important rules to follow to protect your instrument and its functionality.

These rules can be presented as "the 4 golden rules":

- Carrier gas pressure
- Carrier gas quality
- Sample pressure
- Sample quality

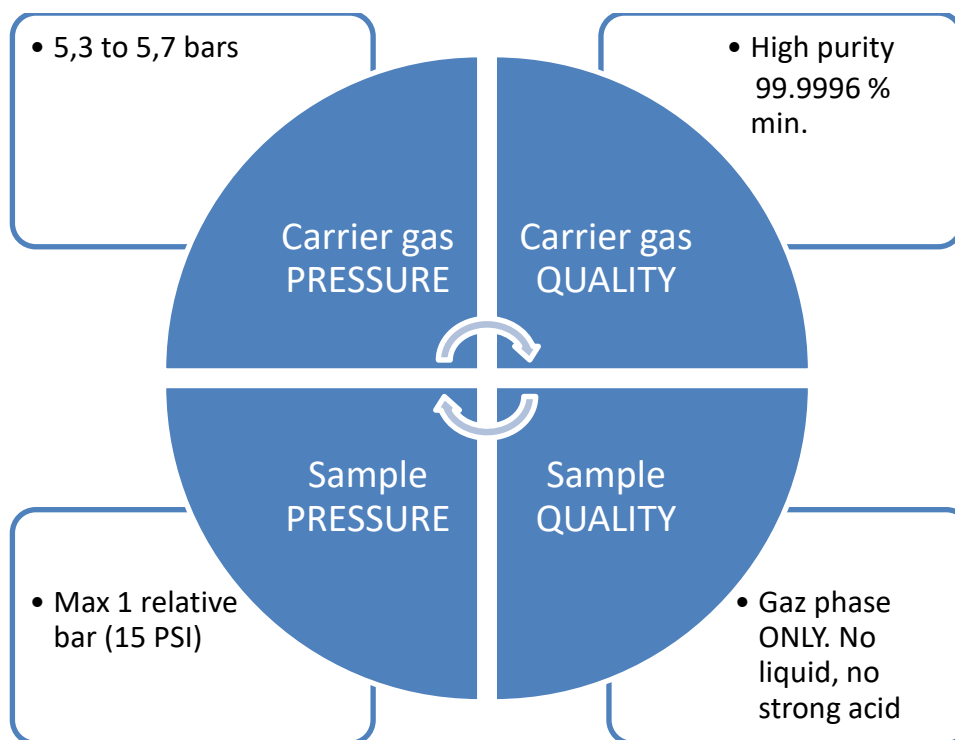

Not respecting these rules highly increases the risk of damaging your instrument. All standard procedures for using MicroGC are derived from these 4 golden rules: the quality of the carrier gas will require a tube purge to ensure this level of quality.

### 5.6.1 Step 1 : Connect the carrier gas(es)

#### Install gas regulators and set pressures

Carrier gas cylinders should have a two-stage pressure regulator to adjust the carrier gas pressure to 550 kPa  $\pm$  10 % (80 psi  $\pm$  10 %). Set cylinder regulator pressure to match the gas inlet pressure.

#### Connect carrier gas to the MicroGC

The MicroGC supports the use of helium, nitrogen, argon and hydrogen. The recommended purity for carrier gas is 99.9996 % minimum. Connect the carrier gas via the **Carrier 5.6 Bars** (1 or 2) ports and turn on the gas flow.

#### Important:

**Do not use any kind of plastic tubing since air will diffuse through the tubing, which may cause noisy baselines and decreased sensitivity. The metal tubing must be clean for GC use. Buy clean tubes intended for chromatography.**

**The use of helium as a carrier gas with the MicroGC configured for Ar/N<sub>2</sub> will decrease the detector sensitivity (about 10 times), invert peaks, without any other incidence.**

**⚠ Using argon as a carrier gas with the MicroGC configured for He will destroy the TCD filaments.**

**The carrier gas must circulate before the analyzer is switched on.**

### 5.6.2 Swagelok fittings

Pneumatic connections use Swagelok fittings. If you are not familiar with this type of fitting, read the procedure below.



**Equipment required:**

- 1/8" preconditioned copper tube
- 1/8" Swagelok nut and ferrules
- Two 7/16" wrenches

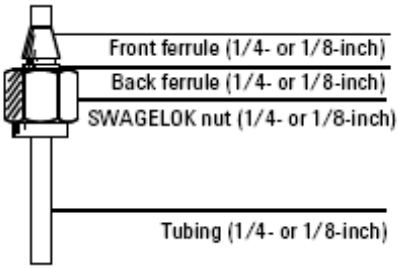
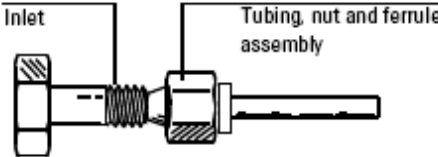
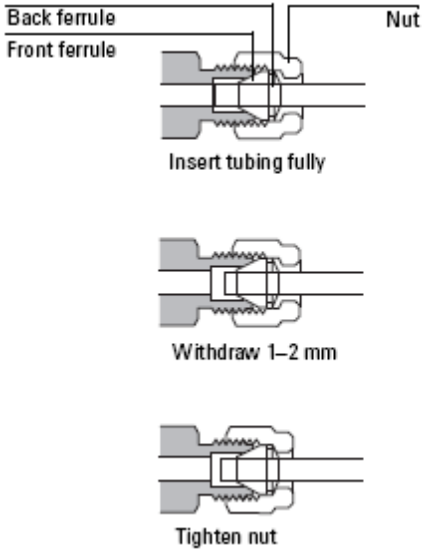
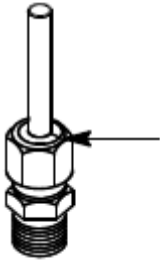
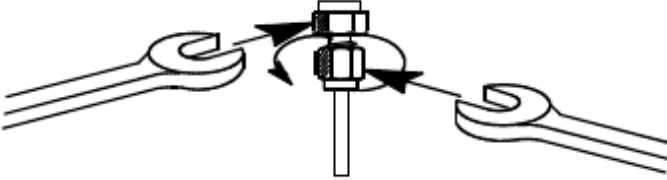
<p>Insert the 1/8" nut and the 2 ferrules.</p>	
<p>Make sure the ferrule is in contact with the inlet, then secure the nut by hand.</p>	
<p>Insert the tube as far as possible into the female part, then remove it from 1 to 2 mm.</p>	
<p>Mark the position of the nut with a pencil.</p>	
<p>Use two 7/16" wrenches to tighten the nut. Tightening requires 3/4 turn with a 1/8" nut.</p>	

## 5.7 Sample lines

### WARNING

**The sample must be clean and dry. Although the internal filter removes many particulate contaminants, samples containing aerosols, excessive amounts of particulate matter, high water concentrations and other contaminants can damage your instrument. The presence of acids (HF, HCl, H<sub>2</sub>SO<sub>4</sub> and HNO<sub>3</sub>) is prohibited.**

**The inlet pressure of the sample must be less than 1 relative bar and its temperature must not exceed 100 °C.**

### 5.7.1 Introduction

Sample conditioning shall be carried out in the immediate proximity in such a way as to reduce lines. Sampling consists of volumes and transfer lines directly connected to the inlet at the MicroGC back panel.

### 5.7.2 Sampling modes

You will need suitable mounting equipment to connect the sample to the MicroGC or an accessory.

Sampling and conditioning are essential points for good analysis and correct results. It is important to study this part as well as possible.

#### Sample with pressure greater than one atmosphere

The best solution is to use a secondary loop close to the MicroGC and at a pressure close to atmospheric pressure. This method offers better results than a direct sample connection to the MicroGC inlet. When calibrating, simply connect the standard mixture instead of the sample. If it is necessary to work under pressure, keep in mind that the sample and standard must be at the same pressure.

#### Sample available at atmospheric pressure

In this case, the MicroGC suction pumps will allow the sample to circulate for an adjustable time in the loops of the injectors of the analytical modules before injection. Here are some examples of samples at atmospheric pressure:

- Atmospheric air: (ex. Online control of atmospheric pollution)
- Tedlar bag: you can adapt a syringe needle on the analyzer sample inlet, the exiting needle will be put in the septum of the bag which will be presented.
- Container with septum: same possibilities as with the Tedlar bag, but in this case, you can only perform several injections, because after the pressure will decrease.

## 5.8 Sample release outlet

In the case of the use of 2 different carrier gases (Argon & Helium), we recommend that you do not group the outlets together. Different types of carrier gases must have different exhausts. Leave these outputs at a constant (almost) atmospheric pressure to avoid "peaks" on the TCD signal.

## 6. Start-up procedure

The start-up procedure includes the different steps presented in the paragraphs below.

### 6.1 Start-up the chromatograph

After connecting and supplying the R490 OBC with carrier gas, you can install the power supply and switch on the analyzer. The switch is located on the rear panel.

The 'POWER' LED lights up. For the moment, the carrier gas does not circulate in the columns.

### 6.2 Launch the software

To access the analyzer's PC (On Board Computer), connect the monitor, keyboard and mouse directly to the instrument. You can also use the Windows remote control tool via the Ethernet link.

To do this, you must enter the following login and password:

LOGIN : R490OBC-XXXX, with XXXX as the serial number of the analyzer.

PASSWORD : MICROGCSRA

After one minute, you will be able to launch Soprane II software to start your analyses if it has not started automatically.

When configuring your analyzer in our factory, we usually use helium as the carrier gas for testing. You can start Soprane Setup to examine the configuration if necessary.

For this, refer to Soprane II software User manual.

### 6.3 Load the PURGE method

**When you turn the MicroGC on, it will load the last method used before turning the instrument off.**

The entire internal pneumatic circuit contains air. If you correctly followed the procedure to connect the carrier gas to the instrument, you purged the external tubing and connection. It is now necessary to purge internal manifolds, regulators and column by loading a "purge" method.

For each module, load a method of this type:

- Injector: 30 °C
- Column: 30 °C
- Pressure: 30 PSI
- **Detector: OFF**

Other parameters have no incidence because no analysis will be done with this method.

The carrier gas is now circulating and purging the whole system including the detector.

**Let the MicroGC purge during approximately 10 minutes.**

## 6.4 Load the test method

At first startup, perform a checkout to make sure the MicroGC is functioning properly.

A test method for each standard column type has been provided in the sections listed in the table below.

**!** If you ordered a Molsieve column, make sure it is conditioned before use. See § 8.4.1 for parameters.

Type de colonne	Tableau
Molsieve 5A	Table 1 on page 23
CP-Sil 5 CB	Table 2 on page 24
CP Sil CB	Table 3 on page 25
PoraPlot 10 m	Table 4 on page 26
Hayesep A 40 cm	Table 5 on page 27
COx 1 m and Al <sub>2</sub> O <sub>3</sub> /KCl	Table 6 on page 28
MES(NGA) and CP-WAX 52 CB	Table 7 on page 29

Use the data system to set up the checkout parameters for each GC channel. Apply the checkout method settings to the MicroGC and allow the instrument to stabilize at the initial operating conditions. Monitor the instrument status using the data system's status display (refer to the data system help for details).

Each test method has been designed to determine if the instrument channel is functioning properly and includes an example test chromatogram.

## 6.5 Perform a series of runs

1. Create a short sequence of at least three runs using the test sample and method.
2. Run the sequence.
3. After the first run, the results for each channel should become similar to the example chromatograms.

## 7. Stop procedure

There are different possibilities for which you will need to stop your R490 OBC:

- Short time stops (less than 2 weeks)
- Long stops (more than 2 weeks).

### 7.1 Short time stops (less than 2 weeks)

To maintain peak operating performance, we recommend that you let the instrument turned on with carrier gas flowing through the system.

To do this, create a method that:

- Turns off the detector filament
- Maintains a small carrier gas purge flow through the system
- Lowers the column temperature

## 7.2 Long stops of R490 OBC

To shut down the R490 OBC:

1. Load a method with these parameters:
  - Injector: OFF
  - Column: OFF
  - Pressure: 30 PSI
  - Detector: OFF
2. Wait until the column temperature is below 60 °C.
3. Turn off the power and unplug any accessory power cord.
4. As soon as the analyzer is turned off, no more gas circulates in the MicroGC. Only then, you can turn off the carrier gas supply.

These procedures help prevent column contamination and degradation.

## 7.3 Moving the analyzer

Here are some useful recommendations if you want to move your analyzer.

- Follow the shutdown procedure described in section 7.2.
- Disconnect the sample and carrier gas connections. Put plugs on the inlets.
- Pack the analyzer properly, taking care to protect the front panel and screen.
- The analyzer is heavy; it is better to be at 2 to lift it.
- Be sure to observe the storage temperatures during transport.
- Ensure that the instrument is adequately protected from moisture and condensation.
- Do not place heavy loads directly on the instrument.

## 8. The MicroGC analytical module

The R490 OBC MicroGC can include 1 to 3 analytical modules. A module contains a gas regulator, an injector, a column and a  $\mu$ -catharometer (see diagram below).

This chapter provides a brief analysis of the major components of the MicroGC and the backflush option.

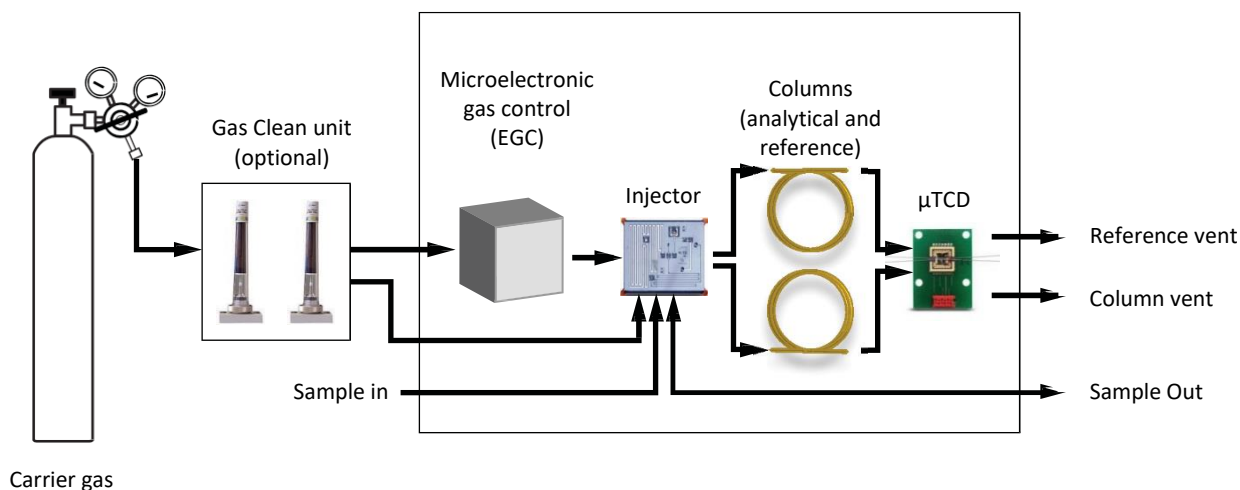

Diagram of an analytical module

## 8.1 Micro Electronic Gas Control (EGC)

The MicroGCs have built-in regulators that can be adjusted to get a constant or programmed pressure control, which, once constant or programmed pressure control is obtained, results in a constant or programmed flow through the injector, column and detector. The pressure range is from 50 to 350 kPa (7 to 50 psi). This pressure sets a continuous flow of carrier gas of about 0.2 to 4.0 mL/min (depending on column length and type).

## 8.2 Inert Sample Path

The R490 OBC MicroGC is equipped with an Ultimet<sup>TM</sup>-treated sample path. This deactivation method ensures the integrity of the sample and helps to achieve the best detection limits possible.

The deactivation is applied to tubing running from the sample inlet to the injector.

## 8.3 Injector

The injector has a built-in 10- $\mu$ L sample loop that is filled with the gaseous sample. The pressure of the sample should be between 0 and 100 kPa (0 to 15 psi) and the sample temperature within 5 to 110 °C  $\pm$  5 °C of the analyzer.

When the chromatographic data system sends a START command, the vacuum pump draws the gas sample through the loop and the injector injects the gas sample from the sample loop into the gas stream. A typical injection time is 40 milliseconds (ms). This equals an average injection volume of 200 nL. Injection time will be rounded to a multiple of 5 ms. A practical minimum value is 40 ms. A value of 0 to 20 milliseconds might result in no injection.

## 8.4 Column

A variety of column configurations are possible on the MicroGC. The columns you require for your specific analyses have been installed at the factory. Other configurations are, of course, possible, but altering the GC channels is a delicate matter that can only be handled by an SRA Instruments technician. The table below shows several standard columns as supplied in the MicroGCs and selected applications. Other columns are available by contacting Agilent Technologies.

Column/Phase type	Target components
Molsieve 5Å	Permanent gases (N <sub>2</sub> /O <sub>2</sub> separation), methane, CO, NO, and so forth. (20 m required for O <sub>2</sub> -Ar baseline separation). Natural gas and biogas analysis. Optional Retention Time Stability (RTS) configuration.
Hayesep A	Hydrocarbons C <sub>1</sub> -C <sub>3</sub> , N <sub>2</sub> , CO <sub>2</sub> , air, volatile solvents, natural gas analysis.
CP-Sil 5 CB	Hydrocarbons C <sub>3</sub> -C <sub>10</sub> , aromatics, organic solvents, natural gas analysis
CP-Sil 19 CB	Hydrocarbons C <sub>4</sub> -C <sub>10</sub> , high boiling solvents, BTX.
CP-WAX 52 CB	Polar volatile solvents, BTX.
PLOT Al <sub>2</sub> O <sub>3</sub> /KCl	Light hydrocarbons C <sub>1</sub> -C <sub>5</sub> saturated and unsaturated. Refinery gas analysis
PoraPLOT U	Hydrocarbons C <sub>1</sub> -C <sub>6</sub> , halocarbons/freons, anesthetics, H <sub>2</sub> S, CO <sub>2</sub> , SO <sub>2</sub> , volatile solvents. Separation of ethane, ethylene, and acetylene.
PoraPLOT Q	Hydrocarbons C <sub>1</sub> -C <sub>6</sub> , halocarbons/freons, anesthetics, H <sub>2</sub> S, CO <sub>2</sub> , SO <sub>2</sub> , volatile solvents. Separation of propylene and propane, coelution of ethylene and acetylene.
CP-COX	CO, CO <sub>2</sub> , H <sub>2</sub> , Air (coelution of N <sub>2</sub> and O <sub>2</sub> ), CH <sub>4</sub> .
CP-Sil 19CB for THT	THT and C <sub>3</sub> -C <sub>6</sub> in Natural Gas Matrix.
CP-Sil 13CB for TBM	TBM and C <sub>3</sub> -C <sub>6</sub> in Natural Gas Matrix.
MES NGA	Unique column specially tested for MES in natural gas (1 ppm).

**!** All columns except the HayeSep A (160 °C) and MES (110 °C) columns can be used up to 180 °C, the maximum temperature of the column oven. Exceeding this temperature will cause the column to lose efficiency instantly and the column module will need replacement. All channels have a built-in protection that prevents a setpoint above the maximum temperature.

### 8.4.1 Molsieve 5Å columns

The Molsieve 5Å column is designed to separate: hydrogen, carbon monoxide, methane, nitrogen, oxygen, and some noble gases. Higher molecular weight components have much higher retention times on this column.

Parameter	4 m Heated	10 m Unheated	20 m Unheated
Column temperature	110 °C	40 °C	40 °C
Injector temperature	110 °C	NA	NA
Column pressure	100 kPa (15 psi)	150 kPa (21 psi)	200 kPa (28 psi)
Sample time	30 s	30 s	30 s
Injection time	40 ms	40 ms	40 ms
Run time	25 s	140 s	210 s
Detector sensitivity	Auto	Auto	Auto
Peak 1	Hydrogen 1,0 %	Neon 18 ppm	Neon 18 ppm
Peak 2	Argon/Oxygen 0,4 %	Hydrogen 1,0 %	Hydrogen 1,0 %
Peak 3	Nitrogen 0,2 %	Argon 0,2 %	Argon 0,2 %
Peak 4	_____	Oxygen 0,2 %	Oxygen 0,2 %
Peak 5	_____	Nitrogen 0,2 %	Nitrogen 0,2 %

- Table 1 -

*Molsieve 5Å 4 m heated*

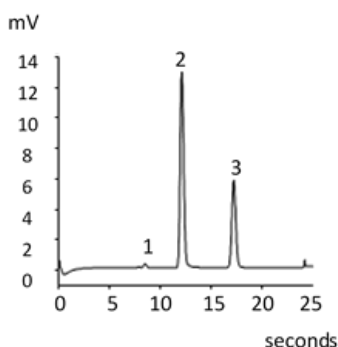

*Molsieve 5Å 10 m unheated*

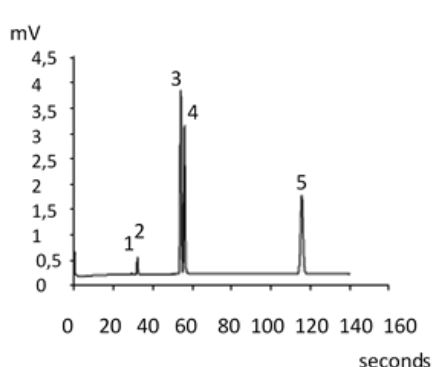

*Molsieve 5Å 20 m unheated*

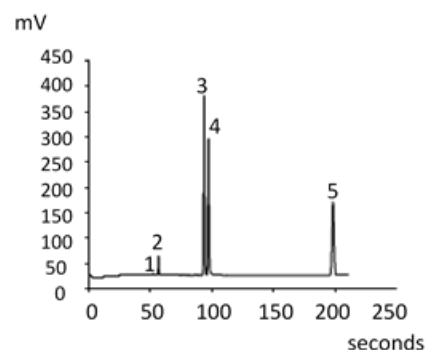

### 8.4.2 CP-Sil 5 CB columns

The natural gas components, mostly hydrocarbons, separate in the same order on the non-polar and medium-polar CP-Sil CB columns. Nitrogen, methane, carbon dioxide, and ethane are not separated on these columns. They produce a composite peak. For separation of these components, consider a HayeSep A column.

Parameter	4 m Heated	6 m Unheated
Column temperature	50 °C	50 °C
Injector temperature	110 °C	NA
Column pressure	150 kPa (21 psi)	150 kPa (21 psi)
Sample time	30 s	30 s
Injection time	40 ms	40 ms
Run time	30 s	30 s
Detector sensitivity	Auto	Auto
Peak 1	Composite balance	Composite balance
Peak 2	Ethane 8,1 %	Ethane 8,1 %
Peak 3	Propane 1,0 %	Propane 1,0 %
Peak 4	i-Butane 0,14 %	i-Butane 0,14 %
Peak 5	n-Butane 0,2 %	n-Butane 0,2 %

- Table 2 -

CP Sil 5 CB 4 m Heated

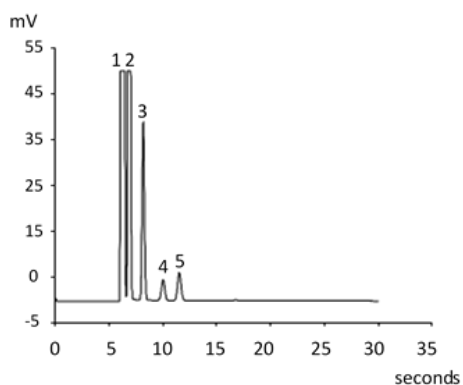

CP Sil 5 CB 6 m Unheated

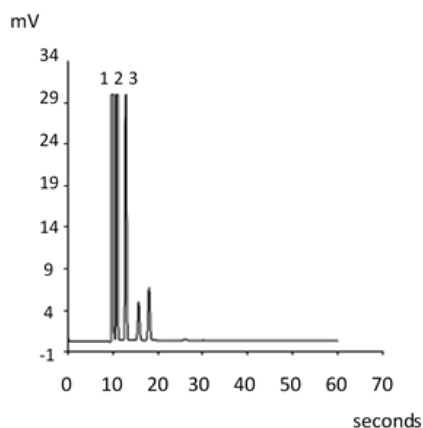



### 8.4.3 CP-Sil CB columns

Parameter	CP-Sil 13 CB 12 m Heated (TBM)	CP-Sil 19 CB 6 m Heated (THT)
Column temperature	40 °C	85 °C
Injector temperature	50 °C	85 °C
Column pressure	250 kPa (38 psi)	200 kPa (25 psi)
Sample time	30 s	30 s
Injection time	255 ms	255 ms
Run time	80 s	35 s
Detector sensitivity	Auto	Auto
Peak 1	Methane balance	Helium balance
Peak 2	TBM 6,5 ppm	THT 4,6 ppm
Peak 3	_____	n-Decane 4,5 ppm

- Table 3 -

CP Sil 13 CB 12 m Heated (TBM)

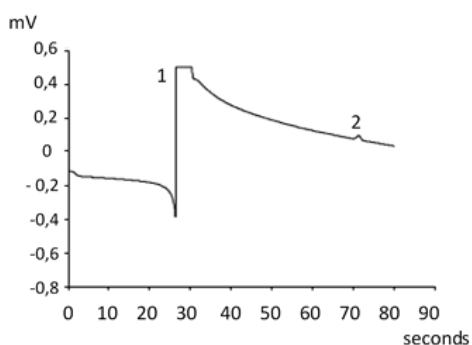

CP Sil 19 CB 6 m Unheated (THT)

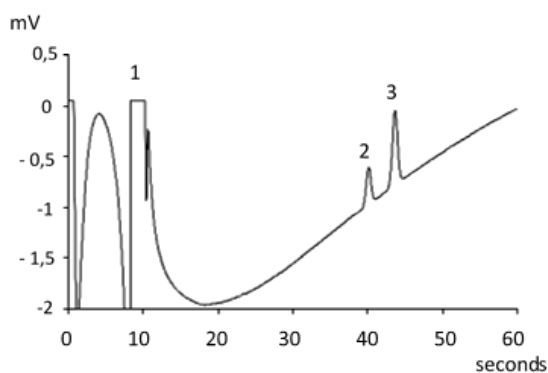

### 8.4.4 PoraPlot 10m column

Parameter	PoraPlot U 10 m Heated	PoraPlot Q 10 m Heated
Column temperature	150 °C	150 °C
Injector temperature	110 °C	110 °C
Column pressure	150 kPa (21 psi)	150 kPa (21 psi)
Sample time	30 s	30 s
Injection time	40 ms	40 ms
Run time	100 s	50 s
Detector sensitivity	Auto	Auto
Peak 1	1	Composite balance
Peak 2	2	Ethane 8,1 %
Peak 3	3	Propane 1,0 %
Peak 4	4	i-Butane 0,14 %
Peak 5	5	n-Butane 0,2 %

- Table 4 -

*PoraPlot U 10 m Heated*

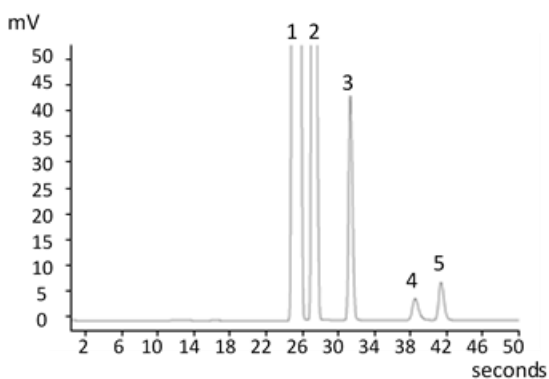

*PoraPlot Q 10 m Heated*

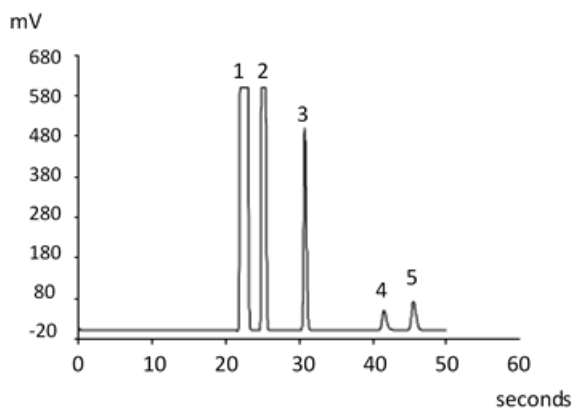

### 8.4.5 Hayesep A 40 cm heated column

The HayeSep A column separates oxygen, methane, carbon dioxide, ethane, acetylene, ethylene, and selected sulfur gases. Nitrogen coelutes with oxygen. Components with a higher molecular weight than propane have long retention times on this column.

! Maximum allowable column temperature is 160 °C.

Parameter	Hayesep A 40 cm Heated
Column temperature	50 °C
Injector temperature	110 °C
Column pressure	150 kPa (21 psi)
Sample time	30 s
Injection time	40 ms
Run time	60 s
Detector sensitivity	Auto
Peak 1	Nitrogen 0,77 %
Peak 2	Methane balance
Peak 3	Ethane 8,1 %

- Table 5 -

*Hayesep A 40 cm Heated*

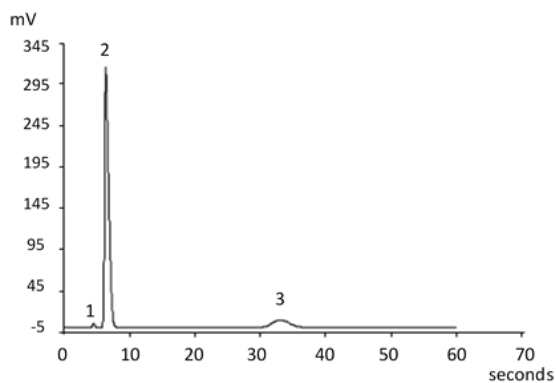

### 8.4.6 COX and Al<sub>2</sub>O<sub>3</sub>/KCl columns

Parameter	COx 1 m Unheated	Al <sub>2</sub> O <sub>3</sub> /KCl 10 m Heated
Column temperature	80 °C	100 °C
Injector temperature	NA	110 °C
Column pressure	200 kPa (28 psi)	150 kPa (21 psi)
Sample time	30 s	30 s
Injection time	40 ms	40 ms
Run time	204 s	60 s
Detector sensitivity	Auto	Auto
Peak 1	Hydrogen 1,0 %	Composite balance
Peak 2	Nitrogen 1,0 %	Ethane 8,1 %
Peak 3	CO 1,0 %	Propane 1,0 %
Peak 4	Methane 1,0 %	i-Butane 0,14 %
Peak 5	CO <sub>2</sub> 1,0 %	n-Butane 0,2 %
Helium balance		

- Table 6 -

*COx 1 m Unheated*

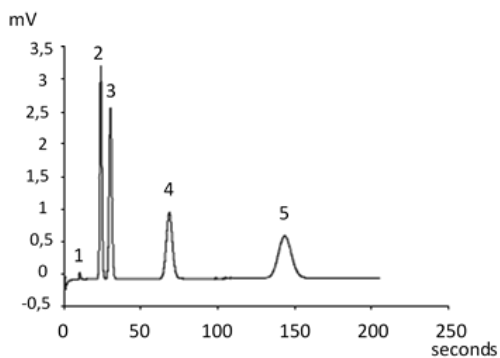

*Al<sub>2</sub>O<sub>3</sub>/KCl 10 m Heated*

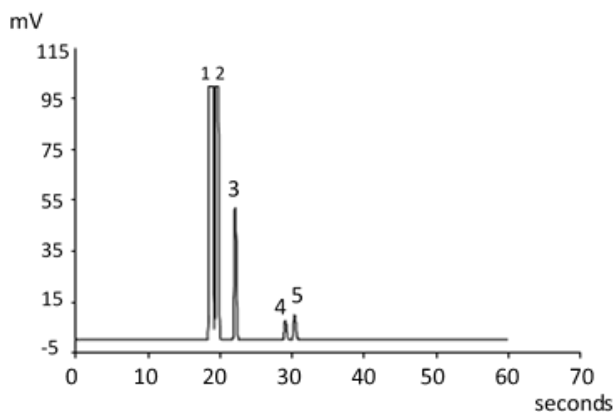

### 8.4.7 MES (NGA) and CP-WAX 52 CB columns

Parameter	MES 10 m Heated (NGA)	CP-WAX 52 CB 4 m Heated
Column temperature	90 °C	60 °C
Injector temperature	110 °C	110 °C
Column pressure	70 kPa (10 psi)	150 kPa (21 psi)
Sample time	30 s	30 s
Injection time	500 ms	40 ms
Run time	120 s	35 s
Detector sensitivity	Auto	Auto
Peak 1	Nitrogen balance	Nitrogen 0,75 %
Peak 2	n-Decane 11,2 ppm	Acetone 750 ppm
Peak 3	MES 14,2 ppm	Methanol 0,15 %
Peak 4		Ethanol 0,30 %
		Helium balance

- Table 7 -

MES 10 m Heated (NGA)

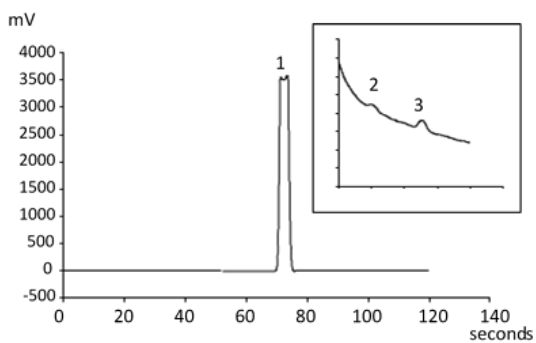

CP-WAX 52 CB 4 m Heated

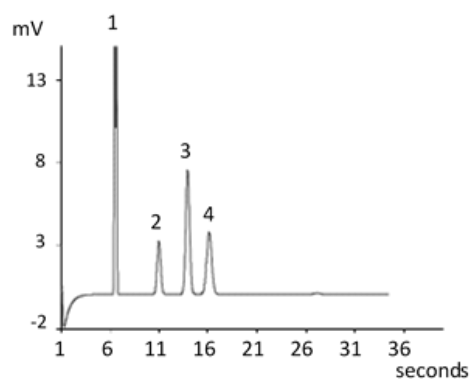

### 8.4.8 Column conditioning

Follow this procedure to make sure that any water that might be present inside the analytical column is removed before the TCD is switched on.

Also follow this procedure if the MicroGC module has been stored for a long period.

**!** The detector filaments may be damaged by improper conditioning. Follow this procedure to avoid damaging the detector filaments.

#### Column conditioning procedure

1. Switch off the TCD filaments in the method.
2. Set the column temperature of the module to the maximum temperature (160°C or 180 °C depending on the column limit). Leave the filaments off.
3. Download this method to the MicroGC.
4. Run the downloaded method to condition the column, preferably overnight.

This will assure you that all the water has been removed from the column and no damage will occur to the TCD filaments.

#### Nitrogen and oxygen merging in Molsieve columns

On a properly activated column, nitrogen and oxygen will be well separated. However, in time you will find that these two peaks begin to merge together. This is caused by water and carbon dioxide present in the sample or carrier gas, adsorbing to the stationary phase.

To restore the column efficiency, condition the column, described above, for about an hour. After reconditioning, you can test the column performance by injecting plain air. If you have a proper separation between nitrogen and oxygen again, the column separation power has been restored. If the MicroGC frequency of use is very high, you might consider routinely leaving the oven temperature at 180 °C overnight. The longer the reconditioning period, the better the column performance.

## 8.5 Backflush option

The analytical modules of the R490 OBC MicroGC can be optionally equipped with a backflush. This has the advantage of protecting the stationary phase of the column from moisture and carbon dioxide. In addition, the analysis times are reduced since late elution compounds, which are therefore of no interest, do not enter the analytical column.

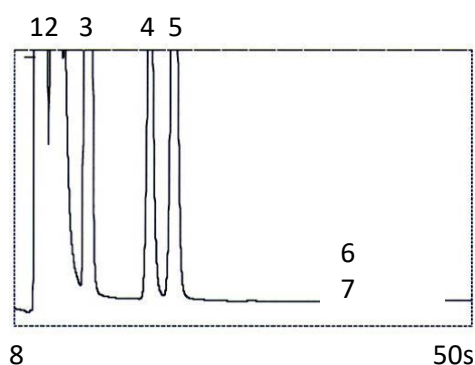

Natural gas analysis, straight

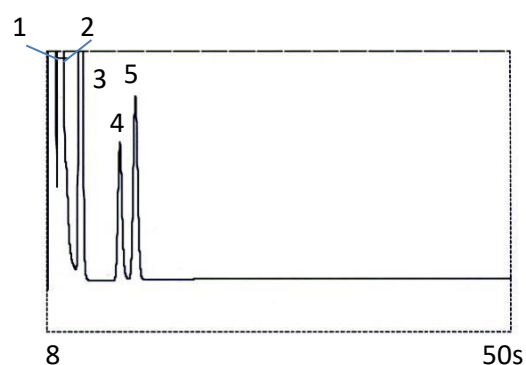

Natural gas analysis, with backflush at 8 seconds

A backflush system always consists of a pre-column and an analytical column. The two columns are coupled at a *pressure point*, which makes it possible to invert the carrier gas flow direction through the pre-column at a preset time, called the *backflush time*. See Figure 2.

The injector, the two columns and the detector are in series.

The sample is injected onto the pre-column where the pre-separation takes place; injection takes place in normal mode. See Figure 1.

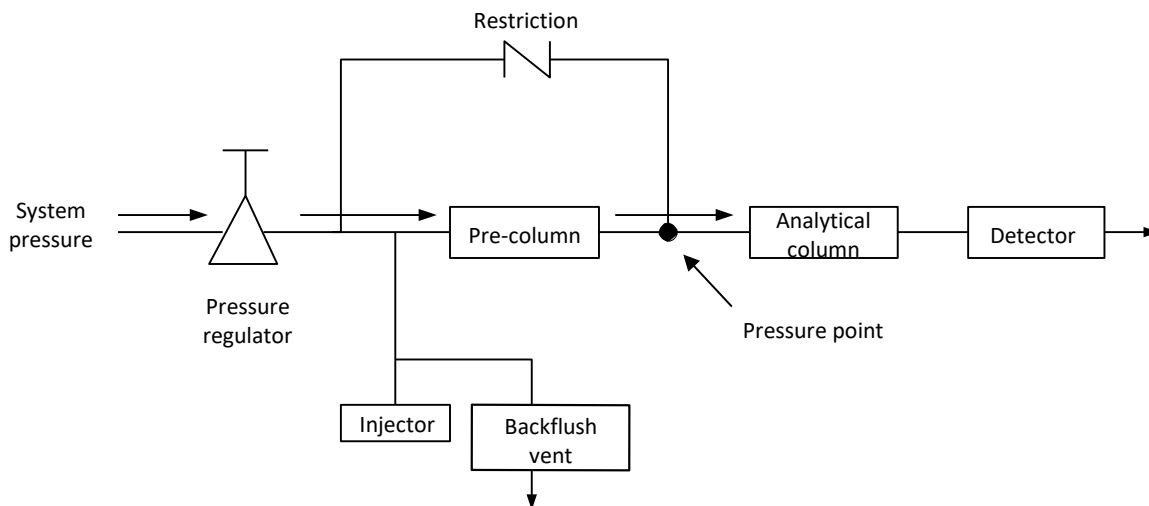

Figure 1

When all compounds to be quantified are transferred to the analytical column, the backflush valve switches (at the backflush time). On the pre-column, the flow inverts and all compounds left on the pre-column now backflush to the vent. On the analytical column the separation continues because there the flow is not inverted. See Figure 2.

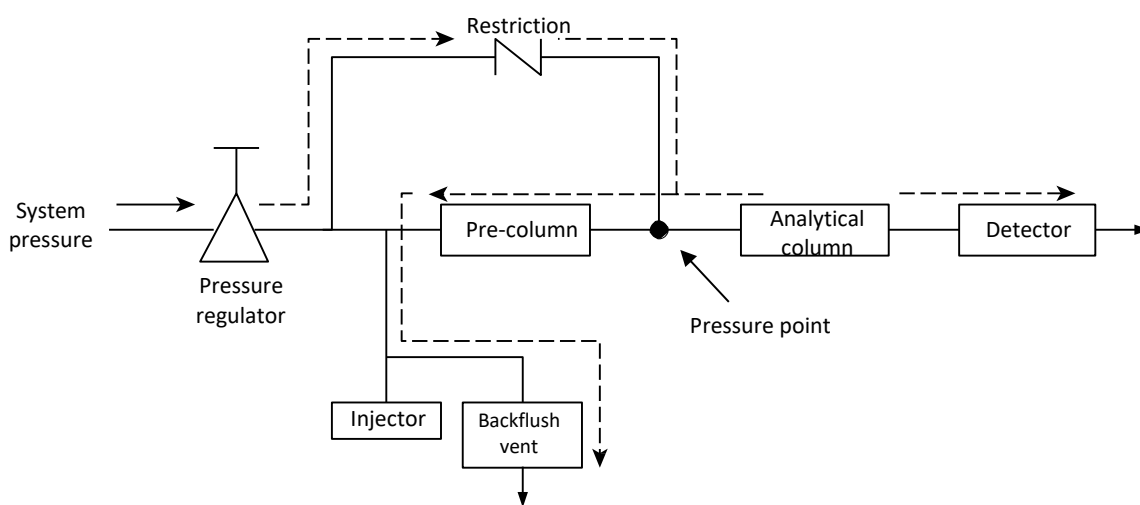

Figure 2

The standby mode is the backflush configuration (if the instrument is equipped with the optional backflush valve).

Backflushing saves the time required to elute high boiling components that are not of interest and ensures that the pre-column will be in good condition for the next run.

### 8.5.1 Tuning the backflush time (except on a HayeSep A channel)

Tuning the backflush time is necessary for each new channel. This chapter describes how to tune the backflush time on all channels except HayeSep A.

#### Tuning procedure for the backflush time

1. Set the backflush time to 0 seconds and analyze the checkout sample or a proper sample for the specific channel. The goal of this is to identify the components in the calibration standard.
2. Change the backflush time to 10 seconds and perform a run.  
The following can be observed:
  - When the backflush time is set too early, the peaks of interest are partially or totally backflushed.
  - If the backflush time is set too late, the unwanted components are not backflushed and show up in the chromatogram.
3. Perform runs with different backflush times until there is no huge difference in the peak of interest. To fine tune the backflush time, set smaller steps (for example 0.10 seconds) until you find the optimal backflush time.

The figure below shows a simple example of tuning the backflush time for the CP-Molsieve 5A channel.

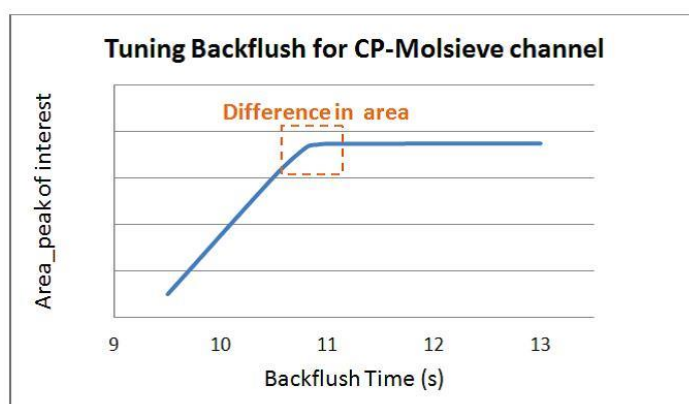

Effect of the backflush time on the peak of interest

### 8.5.2 To disable backflush

To disable backflush, set the **Backflush Time** to 0. This puts the system in normal mode during the entire run.

## 8.6 $\mu$ -catharometer

Each Micro GC channel is equipped with a catharometer ( $\mu$ TCD).

This detector responds to the difference in thermal conductivity between a reference cell (carrier gas only) and a measurement cell (carrier gas containing sample components). The construction of a  $\mu$ TCD is such that the changing thermal conductivity of the carrier gas stream, due to components present, is compared to the thermal conductivity of a constant reference gas stream.



## 9. Communications

This chapter describes the input and output ports accessible inside the R490 OBC MicroGC for interfacing with external devices.

### 9.1 External digital I/O

Connections between MicroGCs and external devices are made with the appropriate cable to the External Digital I/O port.

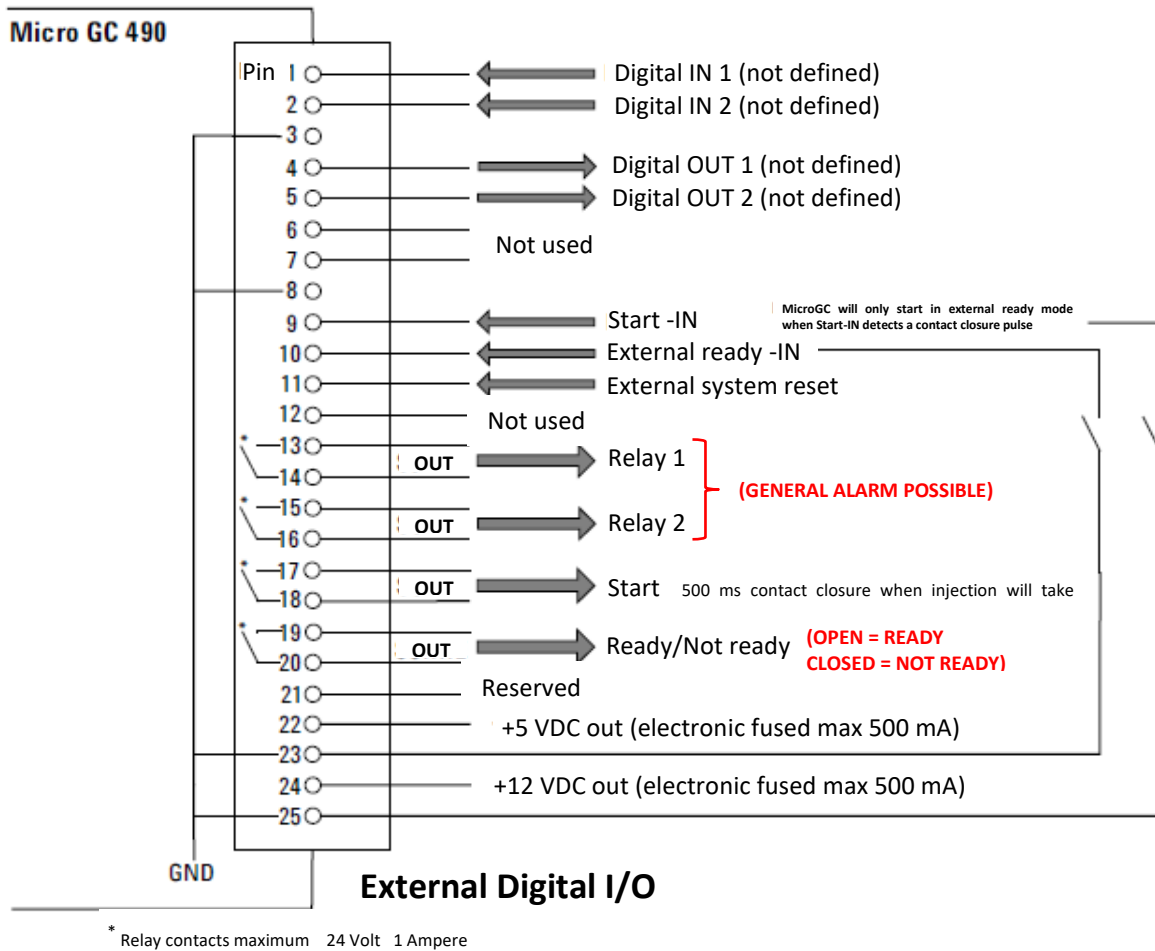

### 9.2 RS-232

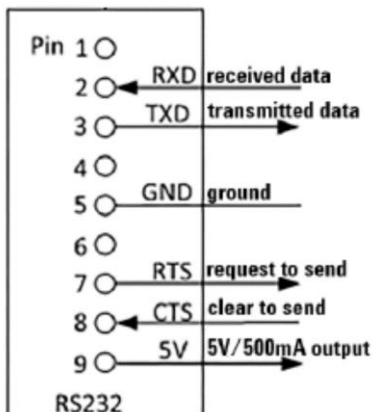

## 10. Errors

### 10.1 Error handling

During operation a series of events and error messages are generated indicating start or finishing of certain actions and procedures as well as smaller and fatal errors somewhere in the instrument. This section describes how the MicroGC reacts to these events or messages.

The following error classes as well as the subsequent actions are available:

**Class 0 *Internal event*.** These are events indicating a certain procedure has started or finished. In no way do they influence the proper functioning of the instrument.

**Class 1 *Advisory fault; the instrument continues*.** These are the less critical advisory errors not requiring immediate action by the user. The ongoing run may be minimally affected by it and thus need not be stopped. Class 1 error messages indicate certain malfunctions of the instrument. Some errors of this type keep the instrument from becoming ready.

**Class 2 *Critical errors for logging; error LED ON*.** These are critical errors for which the user needs immediate warning (a popup or warning may appear in the data system and the Error LED lights). The run in progress is stopped since its results will definitely be wrong. Corrective action by the user or instrument service may be required.

**Class 3 *Fatal errors for logging; instrument shutdown, error LED and buzzer ON*.** These are fatal errors for which the user needs immediate warning. The Error LED lights. An instrument shutdown occurs. Corrective action by the user or service is required.

All errors, regardless of class, are available to the data system under instrument status (for troubleshooting). All Class 1 and higher errors are also logged in the instrument's flash memory.

Individual numbers identify all errors; these numbers are built using the error class and a number. Events are not numbered.

### 10.2 Error list

The General Error State is composed of the following items.

The error must be handled as CLNNN in which:

C = error class (severity)

L = location

NNN = error number or event number.

The Error class can be one of the following values:

- 0 = diagnostic error.
- 1 = advisory error.
- 2 = critical error.
- 3 = fatal error.

There are 4 locations:

- 0 = main board.
- 1 = channel 1.
- 2 = channel 2.
- 3 = channel 3.

The table below lists the possible errors:

Error number	Error class	Event/error code	Description	Action needed
1	0	Init passed (event)	End of initialization phase	
2	0	Pressure restored	Pressure restored after Too Low Pressure	
3	0	Start flush cycle	Is a part of the initialization cycle	
4	0	Flush cycle passed	Is a part of the initialization cycle	
5	0	TCD calibrating	Automatic generation after method activation or download.	TCD off and temp. control to default
6	1	Too low pressure	Pressure drops below 35 kPa	Check gas supply
7	1	Pressure fault	Pressure state not ready after 5 minutes	Check gas supply or replace manifold
8	1	Low battery 1	Battery 1 low power (portable Micro GC only)	Recharge battery
9	1	Low battery 2	Battery 2 low power (portable Micro GC only)	Recharge battery
10	2	Sample line sensor fault	Sample line temperature sensor error	Heater turned off
11	2	Sample line temperature fault	Temperature not reached within 35 min (heater error)	Replace sample line heater
12	2	Injector temperature fault	Temperature not reached within 35 min (heater error)	Replace module
13	2	Column temperature fault	Temperature not reached within 35 min (heater error)	Replace module
14	1	TCD Temperature limit activated	Hardware protection activated	
15	0	EDS logging error	Unable to update EDS log	Call service

Error number	Error class	Event/error code	Description	Action needed
16	1	Low power supply	Voltage < 10 Volt	Recharge battery
17	2	Injector sensor fault	Injector temperature sensor error	Replace module
18	2	Column temperature sensor fault	Column temperature sensor error	Replace module
19	2	TCD control error	TCD voltage not or incorrectly set	Call service
20	2	TCD calibration failed	Any error during TCD calibration	Replace module <sup>2</sup> or TCD controller board
21	2	Hardware reset	Instrument reset request from WS	
22	2	Pressure too high	Pressure > 450 kPa for at least 2 minutes	Replace manifold
23	3	Initialization error	During initialize	Call service
24	3	Internal communication error	During/after initialization, between MPU and IOC/IOE	Call service
25	3	Instrument EDS incorrect	Instrument Electronic Data sheet incorrect	Call service
26	3	EDS incorrect	Electronic Data sheet incorrect	Call service
27	3	Internal power failure	During/after initialization, internal supplies	Call service
28	0	Flush cycle aborted	Flush cycle stopped before completion	
29	0	GC module changed	Changing a channel (controller or module) and restarting the instrument	
30	0	TCD Gain calibrated	End TCD Gain calibration	
31	0	TCD Offset calibrated	End of Offset calibration	
32	0	Null String	Not used	
33	0	ADC reading out of range	Analog Digital Control out of range	
34	0	EDS Analytical Module incorrect	Electronic Data Sheet Analytical Module incorrect	
35	0	EDS Config checksum incorrect	Electronic Data Sheet Configuration checksum incorrect	

Error number	Error class	Event/error code	Description	Action needed
36	0	EDS Logbook checksum incorrect	Electronic Data Sheet Logbook checksum incorrect	
37	0	EDS Protected checksum incorrect	Electronic Data Sheet Protected checksum incorrect.	
38	0	EDS C.C. Config checksum incorrect	Electronic Data Sheet Channel Control checksum incorrect.	
39	0	EDS C.C. Logbook checksum incorrect	Electronic Data Sheet Channel Control Logbook checksum incorrect	
40	0	EDS C.C. Protected checksum incorrect	Electronic Data Sheet Channel Control Protected checksum incorrect	
41	0	EDS A.M. Config. checksum incorrect	Electronic Data Sheet Analytical Module Configuration checksum incorrect	
42	0	EDS A.M. Logbook checksum incorrect	Electronic Data Sheet Analytical Module Logbook checksum incorrect	
43	0	EDS A.M. Protected checksum incorrect	Electronic Data Sheet Analytical Module Protected checksum incorrect	
44	0	EDS Config SVER incorrect	Electronic Data Sheet Configuration Structure Version incorrect	
45	0	EDS Protected SVER incorrect	Electronic Data Sheet Protected Structure Version incorrect	
46	0	EDS C.C. Config SVER incorrect	Electronic Data Sheet Channel Control Structure Version incorrect	
47	0	EDS C.C. Protected SVER incorrect	Electronic Data Sheet Channel Control Protected Structure Version incorrect	
48	0	EDS A.M. Config SVER incorrect	Electronic Data Sheet Analytical Module Configuration incorrect	
49	0	EDS A.M. Protected SVER incorrect	Electronic Data Sheet Analytical Module Protected Structure Version incorrect	
50	0	Pressure Offset calibration complete	Notification Pressure Offset calibration is completed	
51	0	Pressure Offset calibration Failed	Calibration offset out of range	
52	0	Unable to store pressure offset	Pressure off set is out of valid range	
53	2	Temperature sensor disconnected	Temperature sensor not connect to instrument	Call Service
54	1	Not ready to start run	Issued by Safety Control Object in Hardware domain. Bridge Call to GC domain (Reporting Not Ready To Start Run Error)	Check method
54	1	Stream selection failed	Stream selector (VICI) failed switching	Check valve
55	1	Ambient pressure or temperature alarm	Issued by Safety Control Object in Hardware domain whenever ambient temperature has passed a certain value.	
56	1	Column cleaning	Instrument in column cleaning state	NA

Error number	Error class	Event/error code	Description	Action needed
57	1	Equilibrating temperature zones	Instrument stabilizing after column cleaning	Wait until Ready
76	3	IOC Communication error	MPU is not able to communicate with IOC	Call service
77	3	Read main board EDS error	Not able to read Main board EDS	Call service
78	3	Read channel controller EDS error	Unable to read EDS controller	Call service
79	3	Read channel analytical module EDS error	Not able to read analytical module EDS	Call service
990	3	Watchdog Error: Store Application report on flash error	Internal Software Error, can't store application report on flash memory.	Auto reboot
991	3	Watchdog Error: Store ErrorLog report on flash error	Internal Software Error, can't store ErrorLog report on flash memory.	Auto reboot
992	3	Watchdog Error: Instrument frozen (hazardous error)	Internal Software Error, software hanging	Auto reboot
993	3	Watchdog Error: OOA Timer error	Internal Software Error, OOA Timer could not be created.	Auto reboot
994	3	Watchdog Error: ACE reactor stopped	Internal Software Error, ACE reactor stopped.	Auto reboot
995	3	Watchdog Error: Event pump stopped for 20 s	Internal Software Error, Event pump stopped.	Auto reboot
996	3	Watchdog Error: IOC Fatal error 0	Internal Software Error, IOC fatal error 0	Auto reboot
997	3	Watchdog Error: IOC Fatal error 1	Internal Software Error, IOC fatal error 1	Auto reboot
998	3	Watchdog Error: IOC Fatal error 2	Internal Software Error, IOC fatal error 2	Auto reboot
999	3	Watchdog Error: IOC Fatal error 3	Internal Software Error, IOC fatal error 3	Auto reboot

## 11. Technical data

### 11.1 Power supply

220-240 VAC, 50-60 Hz

### 11.2 Dimensions and weight

Width : 482 mm (19")

Height : 225 mm (9")

Depth : 464 mm

Weight : 9 kg (with 3 modules)

### 11.3 Working conditions

- Relative humidity : 0 to 95 %
- No condensation
- Room temperature :
  - Temperature : 0 °C to 40 °C
  - The MicroGC automatically shuts down if the ambient temperature exceeds 65 °C.
- Ambient pressure : The MicroGC automatically shuts down if the ambient pressure is greater than 120 kPa.
- Maximum operation altitude : certified up to 2000 meters above sea level.
- Indoors use

### 11.4 Chromatographic modules

- Up to 3 modules
- 1 or 2 carrier gases

#### 11.4.1 Carrier gases

- Compatible with helium, hydrogen, nitrogen, and argon with 1/8" Swagelok fittings.
- Inlet pressure: minimum = 550 ± 20 Kpa (80 ± 3 psi) 5.5 bars
- Minimum purity: 99.9996 % (for trace analysis 99.9999% is recommended)

#### 11.4.2 Sample and injection

- Gas or vapor samples only
- Sample pressure: from atmosphere to 14.5 psi max (1 bar)

#### 11.4.3 Injector

- Micro-machined injector without moving parts
- Injection volume from 1 to 10 µL
- Heated injector up to 110 °C, including a heated sample transfer line.
- Optional back-flush

#### 11.4.4 Column

Temperature range, up to 180 °C, isothermal

#### 11.4.5 Detector

- Micro-machined thermal conductivity detector (TCD)
- Dual channel (sample flow and reference flow)
- Internal volume per 200 nL channel
- Filaments, oven

#### 11.4.6 TCD operating range

- Concentration, from 1 ppm to 100 %.
- Dynamic linear range,  $10^6$

#### 11.4.7 TCD detection limits

Detection limits are typical for selected components, as long as the column length and conditions used are appropriate.

- 0.5 ppm for WCOT capillary columns between 4 and 10 m long.
- 2 ppm for PLOT columns

#### 11.4.8 Repeatability

< 0.5 % RSD for propane at 1 % molar level for WCOT columns at constant temperature and pressure.

### 11.5 Embedded computer (OBC)

- AXIOMTECH EBox620-841-FL enclosure
- CPU: INTEL E3854 at 1.91 GHz
- 4 USB ports
- 4 serial ports (RS232 and RS485)
- Ethernet port
- SATA hard disk (256 Go)
- Operating temperature range: - 20 to 60 °C

### 11.6 Modbus (optional)

- Serial communication RS232 or RS485
  - RTU
  - ASCII 16 bits
  - ASCII 32 bits (Daniel)
  - JBUS option
  - Configurable slave number
- LAN communication
  - Port 502 configurable
  - Configurable slave number
  - RTU
  - ASCII 16 bits
  - ASCII 32 bits (Daniel)



## 11.7 Inputs / Outputs

See the specific manual of the analyzer

## 11.8 Driving software

Soprane II by default

## 12. EU declaration of conformity

We,



SRA Instruments  
210 Rue des Sources  
69280 MARCY L'ETOILE  
FRANCE

As a manufacturer, declare under our sole responsibility that the instrument type

<b>R490 OBC</b>  Rackable MicroGC analyzer with embedded computer	
--	---

to which this declaration relates, meets the Essential Health and Safety Requirements applicable to it and which are defined by the following Directives and subsequent additions and / or changes:

- 1/ Directive 2014/35/EU, Annex I
- 2/ Directive 2014/30/EU, Annex I

Compliance with the above requirements has been ensured by applying the following standards:

**1/ Directive 2014/35/EU – Low voltage**

- NF EN 61010-1:2010+A1:2019 "Safety requirements for electrical equipment for measurement, control, and laboratory use – Part 1: General requirements"
- NF EN IEC 61010-2-081:2020 "Safety requirements for electrical equipment for measurement, control and laboratory use – Part 2-081: Particular requirements for automatic and semi-automatic laboratory equipment for analysis and other purposes"

**2/ Directive 2014/30/EU – Electromagnetic compatibility**

- EN 61326-1:2013 "Electrical equipment for measurement, control and laboratory use – EMC requirements – Part 1: General requirements"
- NF-EN 61000-4-2:2009 "Electromagnetic compatibility (EMC) – Part 4-2: Testing and measurement techniques – Electrostatic discharge immunity test"

In accordance with the above-mentioned directives (Module A), the above-mentioned equipment is subject, regarding design and production aspects, to *internal production control*: **E FAB 25**

Marcy l'Etoile, 23 November 2020

Legal representative,  
Armando MILIAZZA

 210 rue des Sources  
69280 MARCY L'ETOILE  
Tél. 04.78.44.29.47  
Fax 04.78.44.29.62  
www.sra-instruments.com  
SIRET 842 058 231 0034  

## 13. Frequently Asked Questions

### 13.1 My detector is in default status, what should I do?

If the detector displays default in Soprane Status:

1. Check that you have correctly purged columns by downloading a purge method before starting the detector, that the carrier gas tubing is tight and of quality, connected with a stainless steel tube at 5.6 bars pressure.
2. Check that a carrier gas flow is present at the columns output (on the back of the MicroGC). If it's not the case on one of the two outputs, contact SRA Instruments after-sales service.
3. Check that the carrier gas used is correctly configured in Soprane Setup software.

If all these verifications are carried out and correct, please, download again the purge method and look at the status.

If the detector is again in default, contact SRA Instruments after-sales service.

### 13.2 My pressure sensor is in default status, what should I do?

1. Check that the carrier gas tubing is correctly fed, tight and with a pressure at 5.6 bars.
2. If there are two carrier gas inputs on the MicroGC, check that the two inputs are correctly connected.
3. If necessary, check that the carrier gas is effectively coming at the carrier gas tubing output, at the MicroGC inlet.
4. Check that the columns outputs are at atmospheric pressure and not blocked.

If all these verifications are carried out and correct, download again the method and look at the status.

If the pressure sensor is again in default, please contact SRA Instruments after-sales service.

### 13.3 I change the carrier gas, what should I do?

Before changing of carrier gas type, follow the procedure to switch off your MicroGC.

Then, configure the carrier gas type as it is described in section 5.6.

It is then highly advised to carry out a bake out during minimum one night to purge all the columns and to rebalance the column with the use of a new gas.

Do not forget that a bad carrier gas configuration can irremediably damage the detector.